



## WT-SFP+-ER

### 10Gb/s 1550nm SFP+ Transceiver

#### PRODUCT FEATURES

- Hot-pluggable SFP+ footprint
- Supports 9.5 to 10.3Gb/s bit rates
- Power dissipation < 1.5W
- Single 3.3V power supply
- Maximum link length of 40km
- 1550nm EML transmitter, PIN photo-detector
- Duplex LC connector
- Power dissipation < 1.5W
- Built-in digital diagnostic functions
- Case temperature range : -5°C to 70°C



#### APPLICATIONS

- 10GBASE-ER/EW 10G Ethernet

#### STANDARD

- Compliant with SFF-8472 SFP+ MSA.
- Compliant to SFP+ SFF-8431 and SFF-8432.
- Compliant to 802.3ae 10GBASE-ER.
- RoHS Compliant.



## PRODUCT DESCRIPTION

WT-SFP+-ER is designed for use in 10-Gigabit Ethernet links up to 40km over single mode fiber. The module consists of 1550 EML Laser, InGaAs PIN and Preamplifier in a high-integrated optical sub-assembly. Digital diagnostics functions are available via a 2-wire serial interface, as specified in SFF8472. The module data link up to 40km in 9/125um single mode fiber.

### I. Absolute Maximum Ratings

Parameter	Symbol	Min.	Typ.	Max.	Unit	Note
Storage Temperature	Ts	-40		85	°C	
Storage Ambient Humidity	HA	5		85	%	
Power Supply Voltage	VCC	-0.5		4	V	
Signal Input Voltage		-0.3		Vcc+0.3	V	
Receiver Damage Threshold		+4			dBm	

### II. Recommended Operating Conditions

Parameter	Symbol	Min.	Typ.	Max.	Unit	Note
Operating Case Temperature	Tcase	-5		70	°C	Note (1)
Ambient Humidity	HA	5		85	%	
Power Supply Voltage	VCC	3.14	3.3	3.46	V	
Power Supply Current	ICC			450	mA	
Power Supply Noise Rejection				100	mVp-p	100Hz to 1MHz
Transmission Distance				40	km	16:1 split
Coupled fiber		Single mode fiber				ITU-T G.653

Note: -10 to 60degC with 1.5m/s airflow

### III. Optical Characteristics



Parameter	Symbol	Min.	Typ.	Max.	Unit	Note
<b>Transmitter</b>						
Average Launched Power	PO	-2		+4	dBm	Note (1)
Extinction Ratio	ER	6			dB	
Center Wavelength	$\lambda_c$	1530	1550	1565	nm	
Spectrum Band Width (RMS)	$\sigma$			1.0	nm	
SMSR		30			dB	
Transmitter OFF Output Power	POff			-40	dBm	
Optical Rise/Fall Time	tr/ta		100	260	ps	Note (2)
Transmitter and Dispersion Penalty	TDP			3.0	dB	
Output Eye Mask	Compliant with IEEE 0802.3ae					
<b>Receiver</b>						
Input Optical Wavelength	$\lambda$	1270		1610	nm	
Receiver Sensitivity				-15	dBm	Note (3)
Input Saturation Power (Overload)	Psat	0.5			dBm	
LOS Detect -Assert Power	PA	-28			dBm	
LOS Detect - Deassert Power	PD			-19	dBm	
LOS Detect Hysteresis	PHYS	0.5			dB	

Note:

1. Launched power (avg.) is power coupled into a single mode fiber with master connector. (Before of Life)
2. These are unfiltered 20-80% values.
3. Measured with conformance test signal for BER =  $10^{-12}$ .@10.3125Gbps, PRBS=2<sup>31</sup>-1,NRZ

#### IV. Electrical Interface Characteristics



Parameter	Symbol	Min.	Typ.	Max.	Unit	Note
<b>Transmitter</b>						
Differential line input Impedance	RIN		100		Ohm	
Differential Data Input Swing	VDT	300		700	mVp-p	
Transmit Disable Voltage	Vdis	2		Vcc	V	LVTTL
Transmit Enable Voltage	Ven	Vee		Vee+0.8	V	
<b>Receiver</b>						
Differential Data Output Swing	VDR	400		850	mVp-p	Note (1)
LOS Output Voltage-High	VLOSH	Vee		Vee+0.8	V	LVTTL
LOS Output Voltage-Low	VLOSL	2		VccHOST	V	

Note: Into 100Ω differential termination.

## V. Pin Description

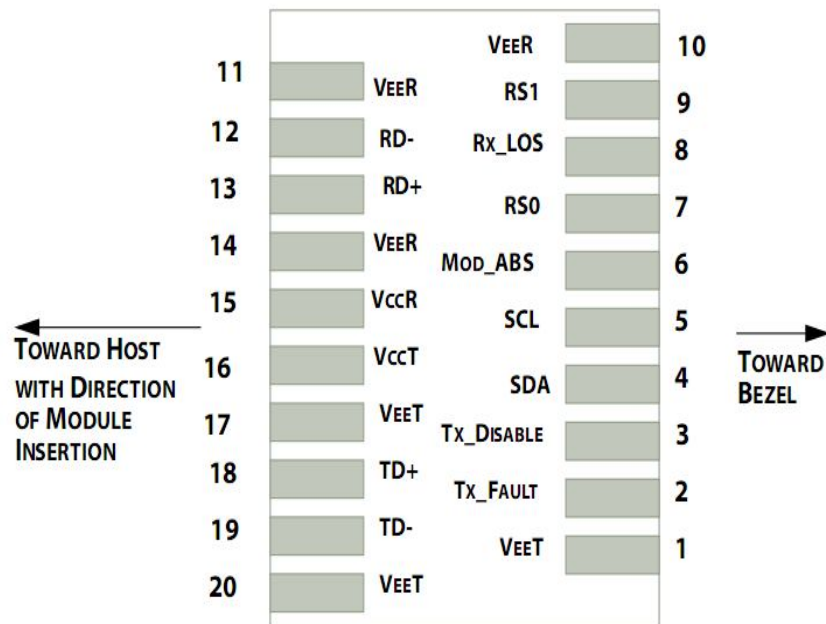

Pin out of Connector Block on Host Board



Pin	Symbol	Name/Description	Ref.
1	V <sub>EET</sub>	Transmitter Ground (Common with Receiver Ground)	1
2	T <sub>FAULT</sub>	Transmitter Fault.	2
3	T <sub>DIS</sub>	Transmitter Disable. Laser output disabled on high or open.	3
4	SDA	2-wire Serial Interface Data Line	4
5	SCL	2-wire Serial Interface Clock Line	4
6	MOD_ABS	Module Absent. Grounded within the module	4
7	RS0	Rate Select 0	5
8	LOS	Loss of Signal indication. Logic 0 indicates normal operation.	6
9	RS1	No connection required	1
10	V <sub>EER</sub>	Receiver Ground (Common with Transmitter Ground)	1
11	V <sub>EER</sub>	Receiver Ground (Common with Transmitter Ground)	1
12	RD-	Receiver Inverted DATA out. AC Coupled	
13	RD+	Receiver Non-inverted DATA out. AC Coupled	
14	V <sub>EER</sub>	Receiver Ground (Common with Transmitter Ground)	1
15	V <sub>CCR</sub>	Receiver Power Supply	
16	V <sub>CCT</sub>	Transmitter Power Supply	
17	V <sub>EET</sub>	Transmitter Ground (Common with Receiver Ground)	1
18	TD+	Transmitter Non-Inverted DATA in. AC Coupled.	
19	TD-	Transmitter Inverted DATA in. AC Coupled.	
20	V <sub>EET</sub>	Transmitter Ground (Common with Receiver Ground)	1

**Notes:**

1. Circuit ground is internally isolated from chassis ground.
2. T<sub>FAULT</sub> is an open collector/drain output, which should be pulled up with a 4.7k – 10k Ohms resistor on the host board if intended for use. Pull up voltage should be between 2.0V to Vcc + 0.3V. A high output indicates a transmitter fault caused by either the TX bias current or the TX output power exceeding the preset alarm thresholds. A low output indicates normal operation. In the low state, the output is pulled to <0.8V.
3. Laser output disabled on T<sub>DIS</sub> >2.0V or open, enabled on T<sub>DIS</sub> <0.8V.
4. Should be pulled up with 4.7kΩ- 10kΩ host board to a voltage between 2.0V and 3.6V. MOD\_ABS pulls line low to indicate module is plugged in.
5. Internally pulled down per SFF-8431 Rev 4.1.
6. LOS is open collector output. It should be pulled up with 4.7kΩ – 10kΩ on host board to a voltage between 2.0V and 3.6V. Logic 0 indicates normal operation; logic 1 indicates loss of signal.



## VI. Recommended Interface Circuit

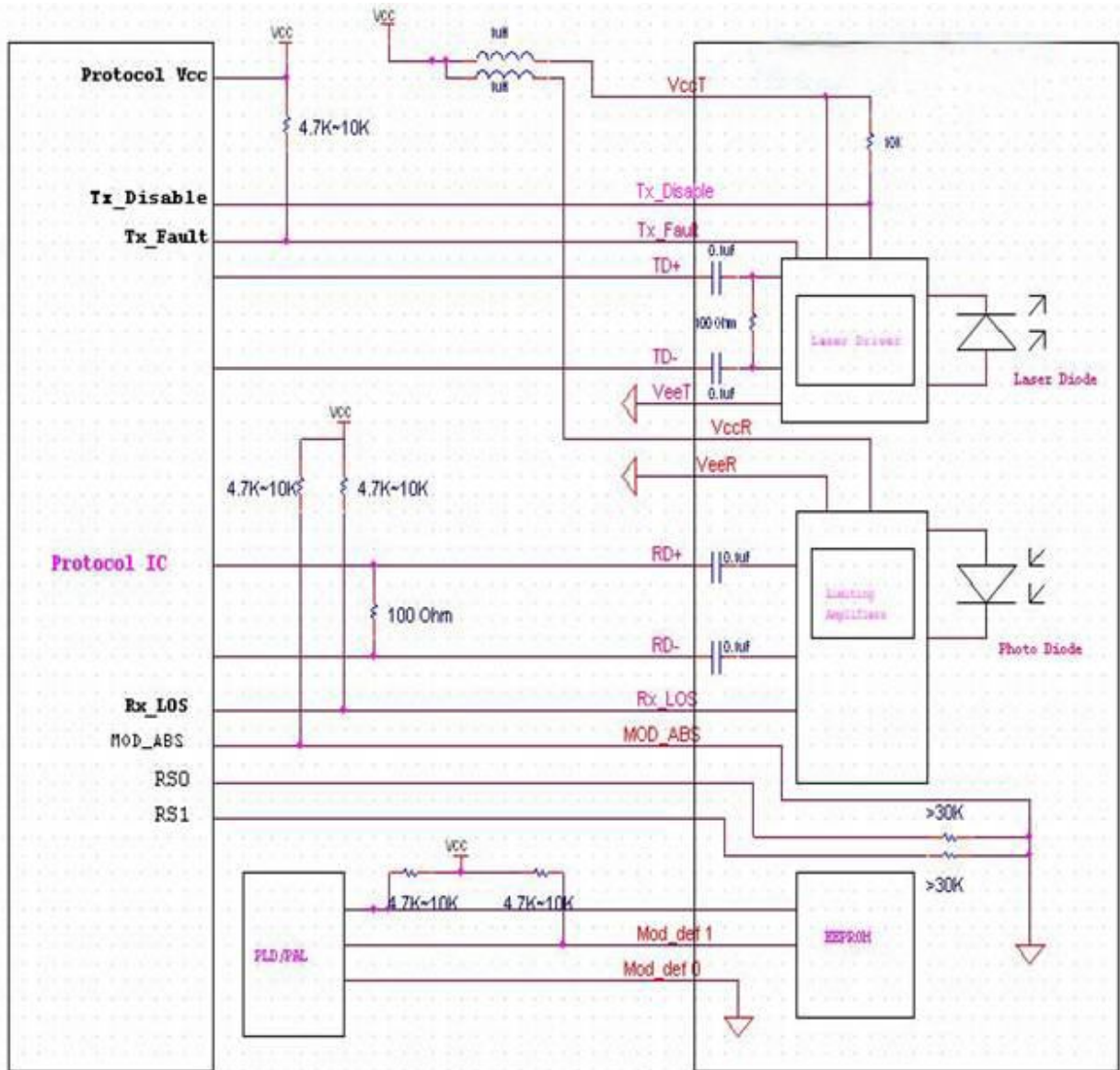



## VII. Outline Dimensions

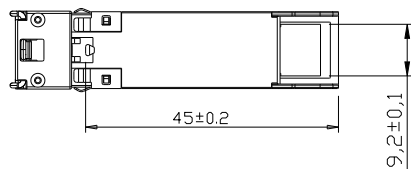
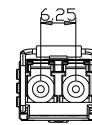
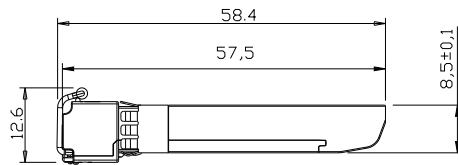
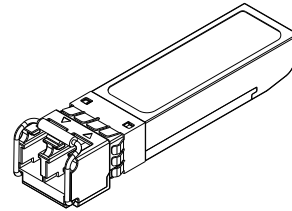
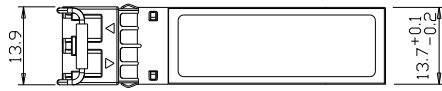

Units in mm

## VIII. Regulatory Compliance

Feature	Reference	Performance
Electrostatic discharge (ESD)	IEC/EN 61000-4-2	Compatible with standards
Electromagnetic Interference (EMI)	FCC Part 15 Class B EN 55022 Class B (CISPR 22A)	Compatible with standards
Laser Eye Safety	FDA 21CFR 1040.10, 1040.11 IEC/EN 60825-1, 2	Class 1 laser product
Component Recognition	IEC/EN 60950, UL	Compatible with standards
ROHS	2002/95/EC	Compatible with standards
EMC	EN61000-3	Compatible with standards